



Xtand™ Go Z1

Deluxe iPhone Car Mount





DESIGN IN
GERMANY

Adjust to Fit Your Device

Expandable to Fit Your Device, up to 3.6" (92mm)

Fits smartphone in a case

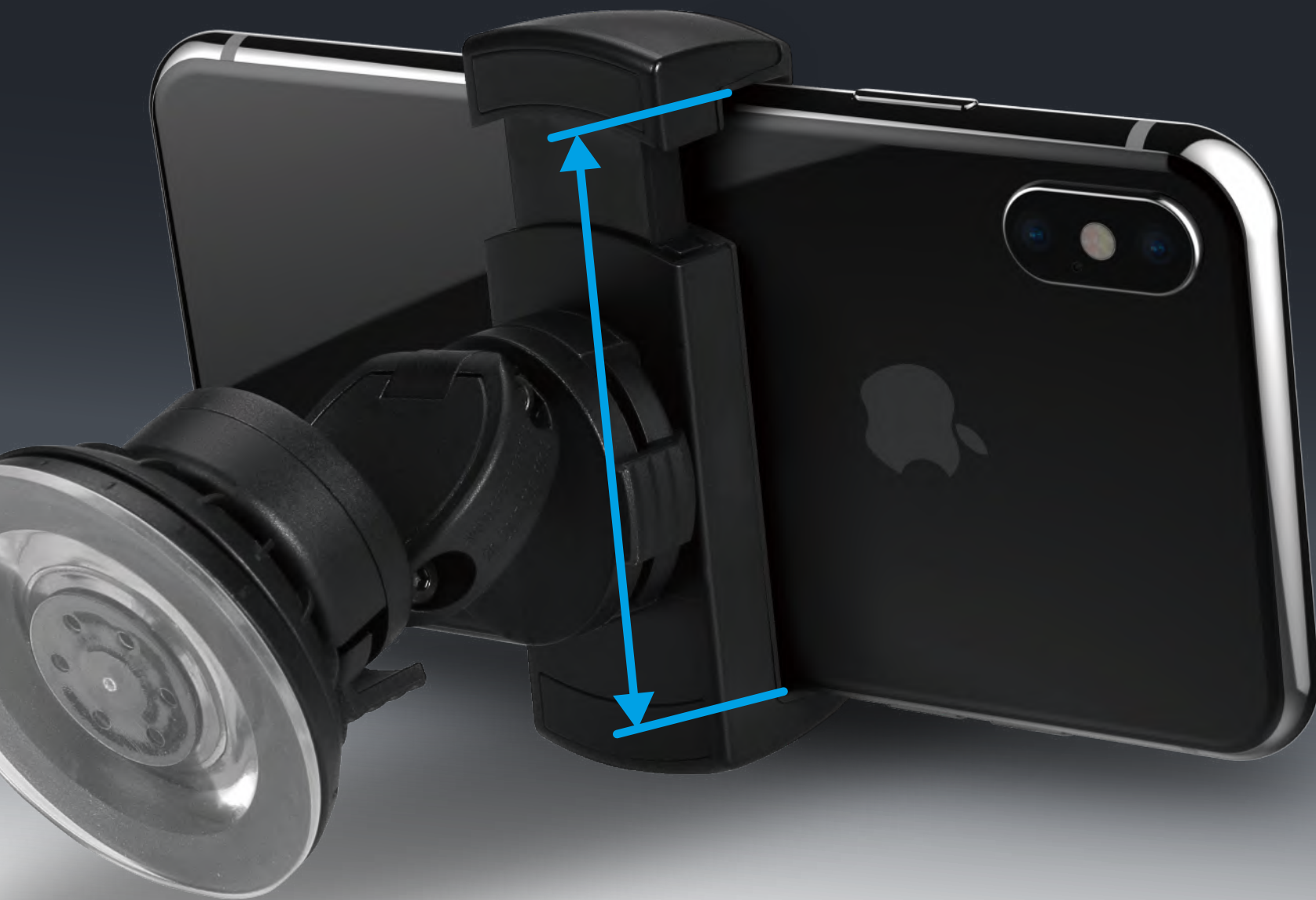

3-Sectional Arm Exclusive Design

Free rotation, tilt, and length

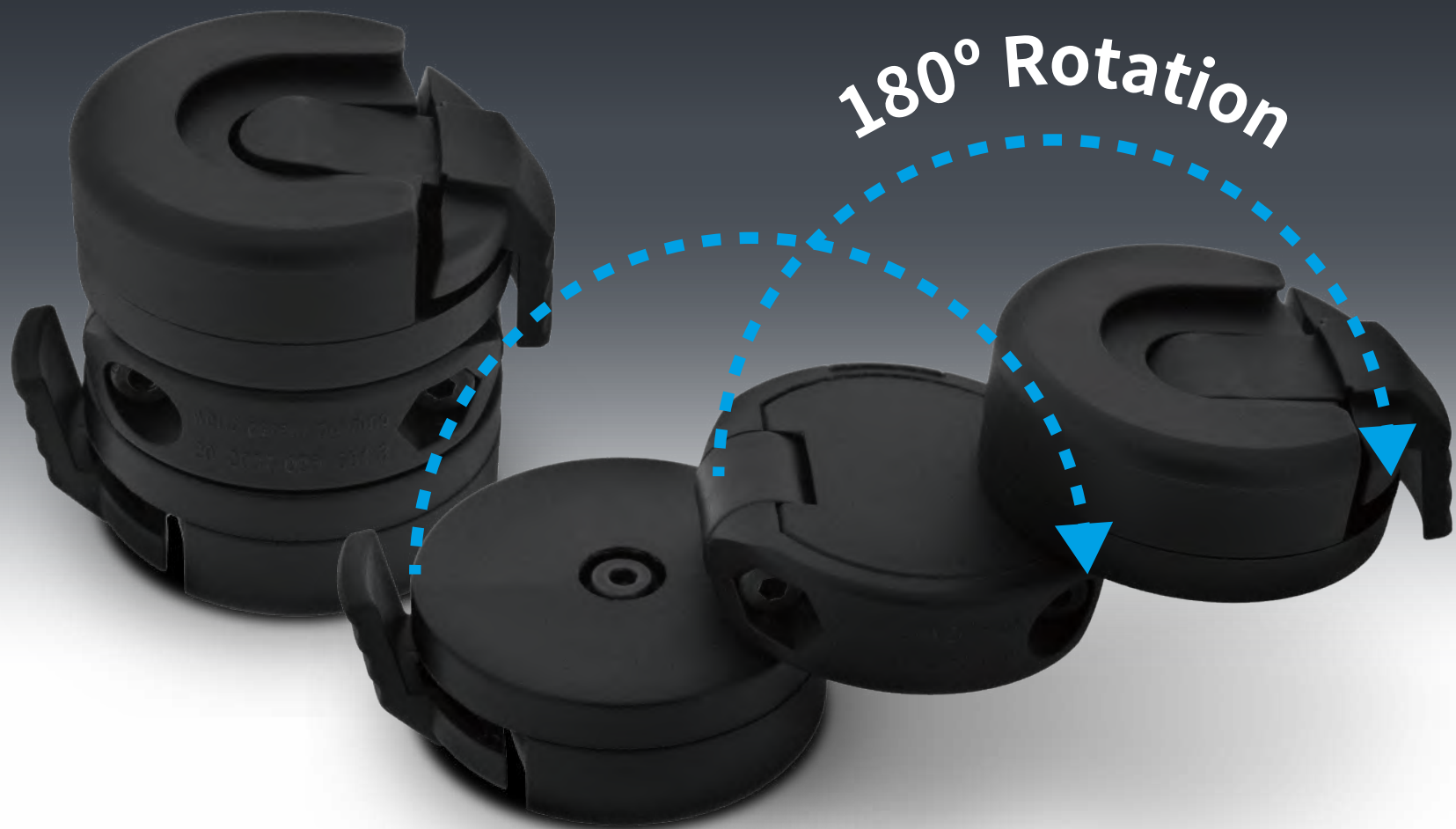

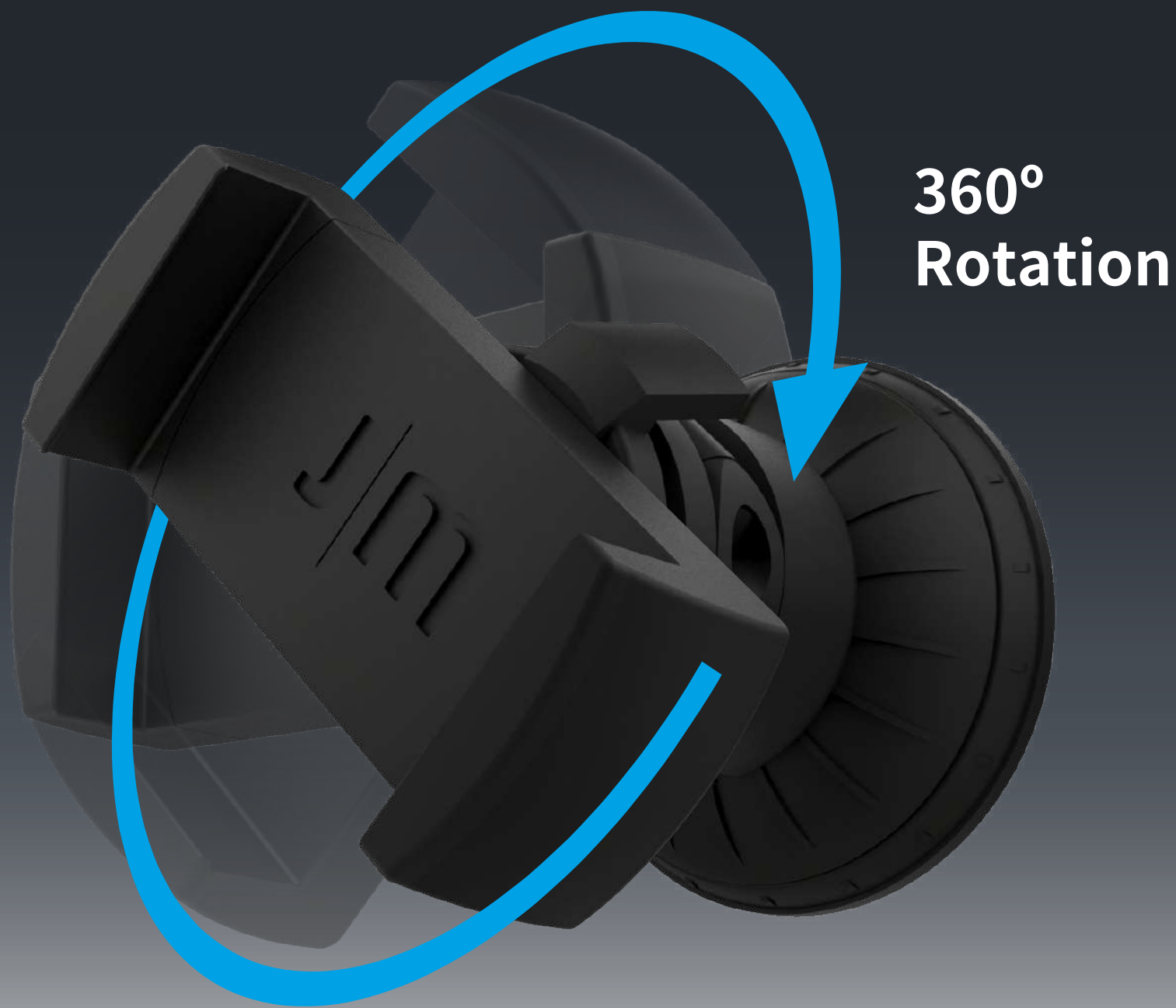

**360°
Rotation**

Various Viewing Angles

Turn landscape or portrait on-the-fly

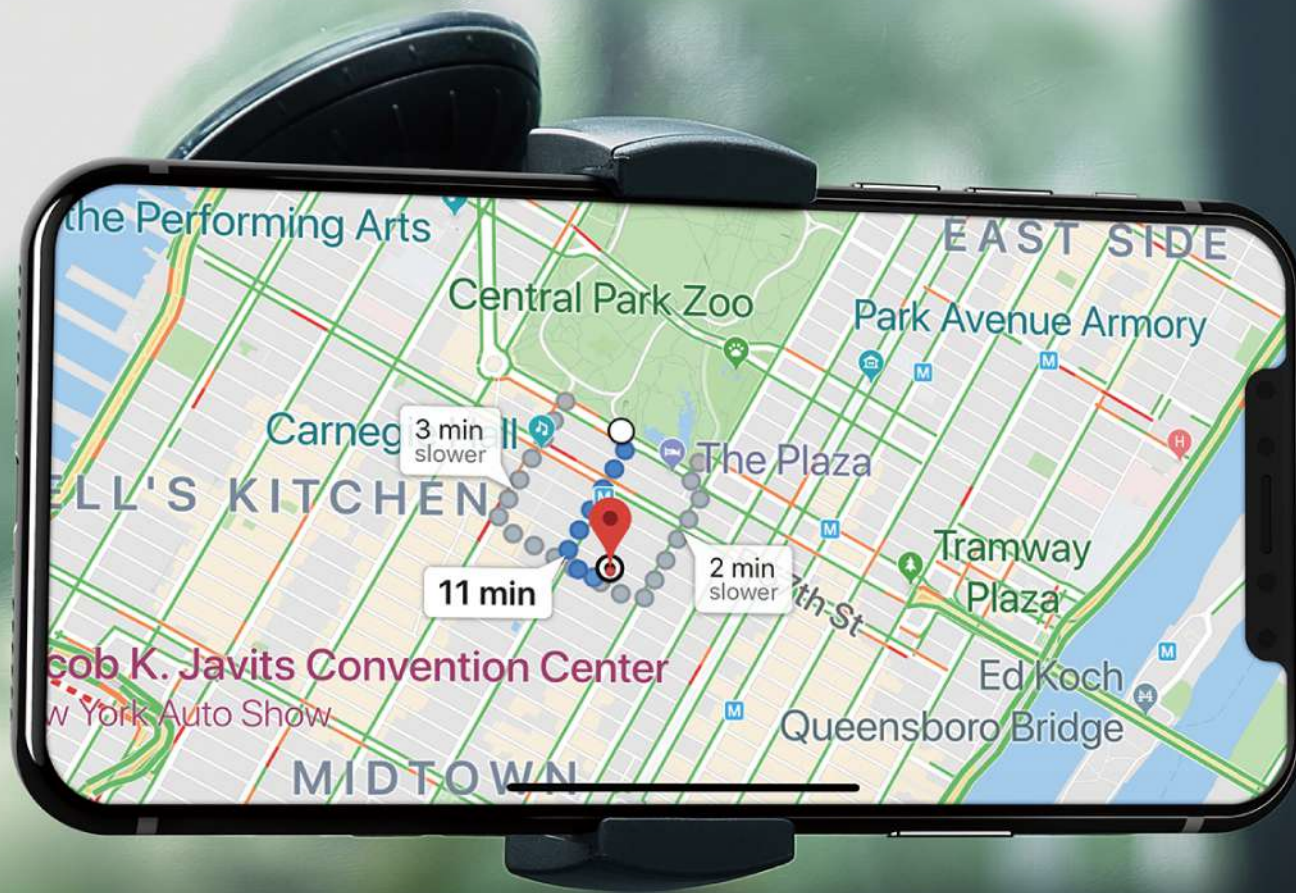

Scenario 1: Mount on Windshield Using the Suction Cup



Air tight suction cup easily
tighten or remove with one hand

Scenario 2: Mount on Dashboard Using the Go Button

Secure the Go Button 3M harmless adhesive on dashboard

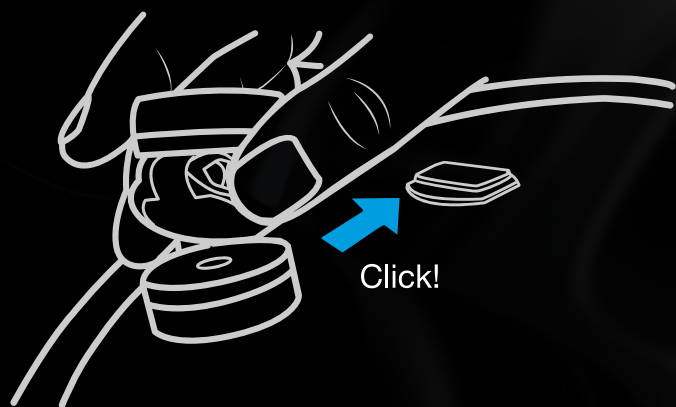
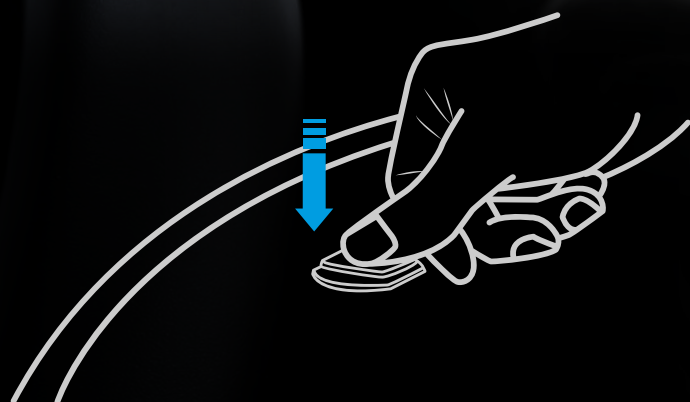

Scenario 3: Mount Phone Directly On Extension Arm Without Bracket

Secure the Go Button 3M harmless adhesive
on back of iPhone or case



**3M Harmless
Automotive Adhesive**

Scenario 4: Mount Apple MagSafe Charger On Extension Arm

Secure the Go Button on the back of
Apple MagSafe Charger

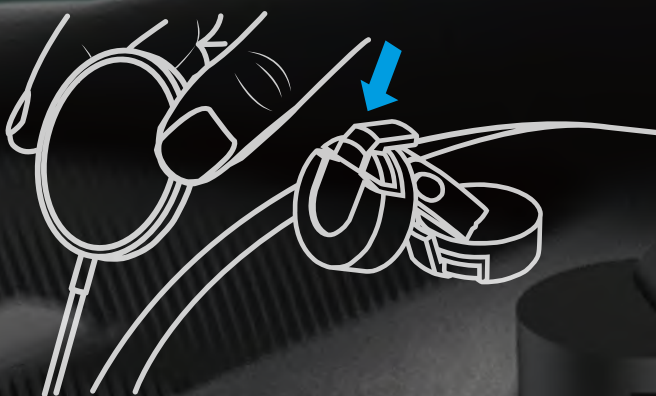

*Apple MagSafe Charger not included.

*The magnetic alignment experience only applies to iPhone 12 series.

Replaceable Parts Minimize Cost of Ownership

Xtand™ Go Z1 Kit



Go Button Kit

No Head Dipping

Built-in Hex Screw Adjusts Tensions for Heavy Phones



Quality Assurance: Endurance Testing



Folds
3000+ times

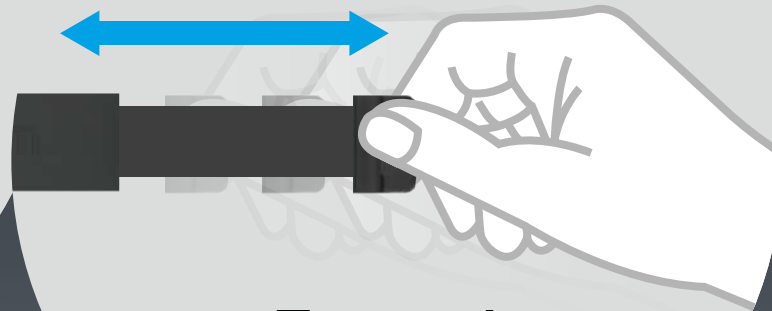

Expands
2000+ times



10kg
Impact

Quality Assurance: Extreme Temperature Testing

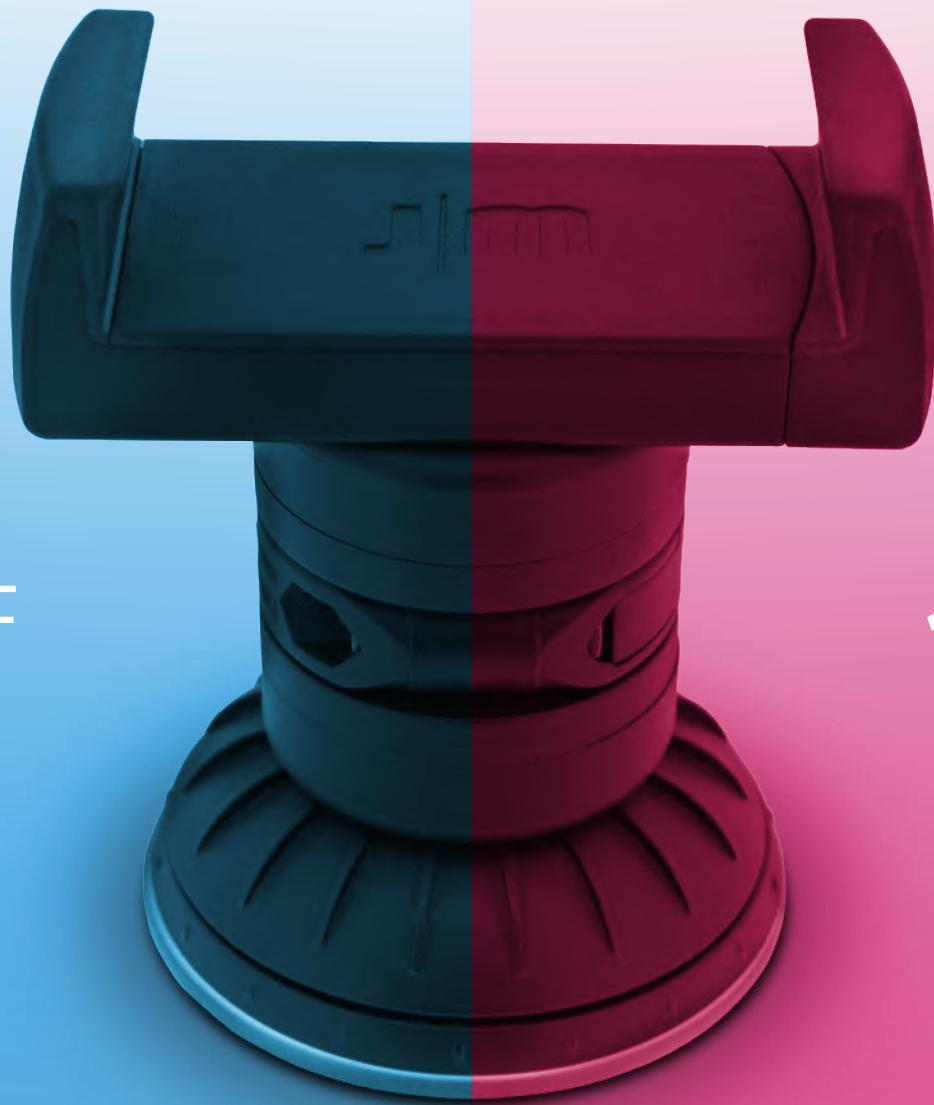

-40°F

158°F

Product Packaging

